

(Not to scale)

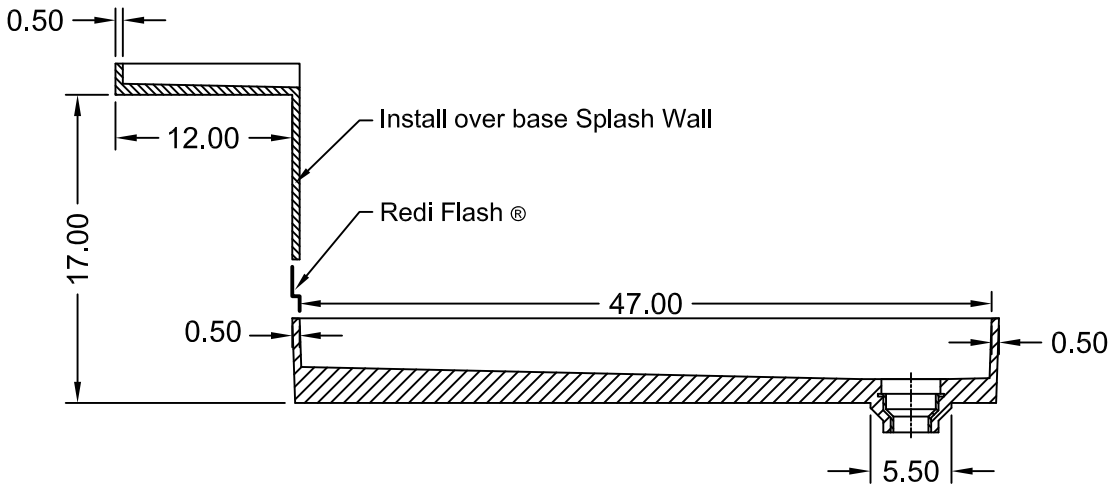

SECTION A-A

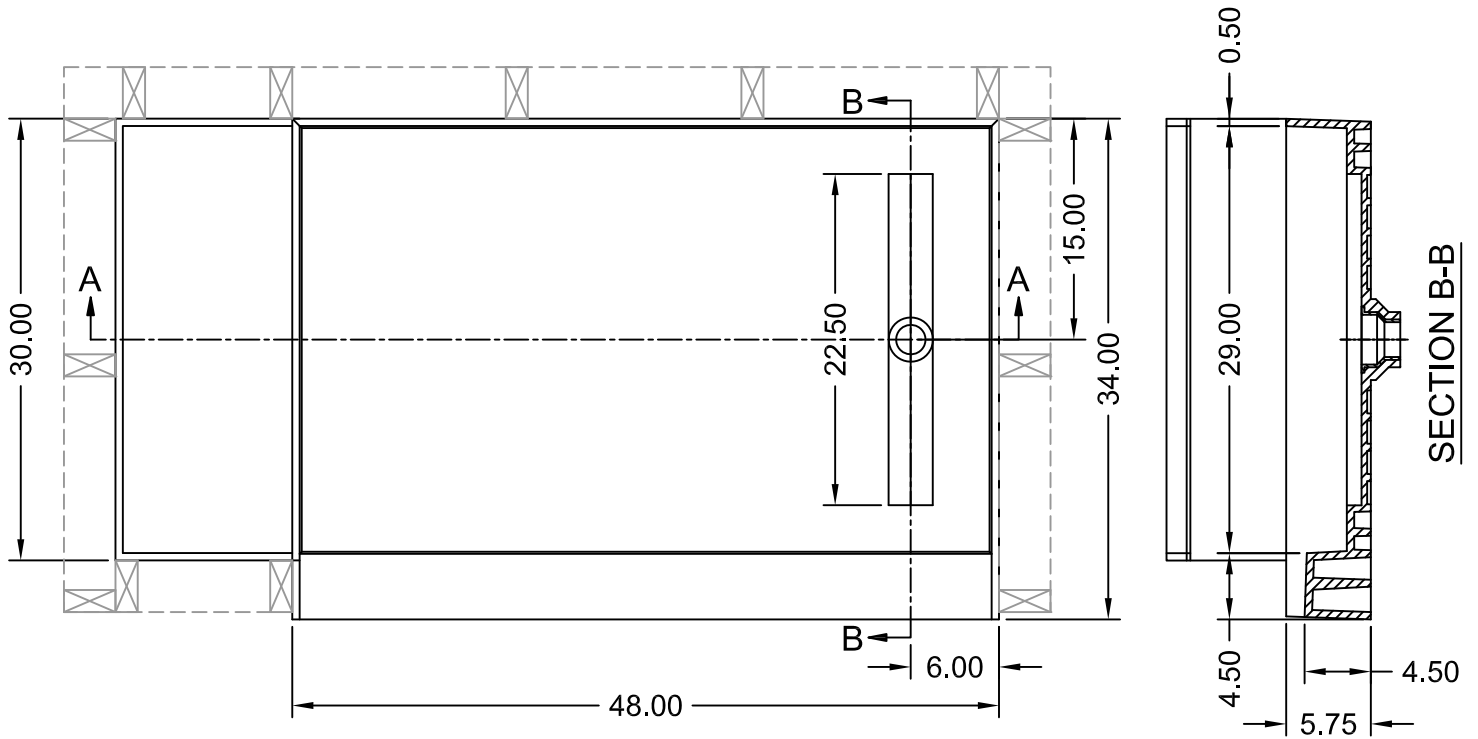

ANSI Z124.1-95  
ANSI Z124.2-95  
ICC/ANSI A117.1.98

ASTM F462-79  
B45.0-02  
B45.5-02

Toll Free 800.232.6156  
Tel: 954.323.0125  
Fax: 954.344.8064

techsupport@tileredi.com  
www.tileredi.com



V.2013.09.02